



932全包 不锈钢

可选颜色:
Optional color:



SS/G
拉丝银

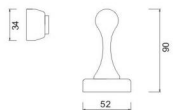

2001全包 不锈钢

可选颜色:
Optional color:



SS/G
拉丝银

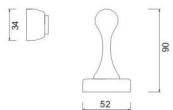

905特大加厚 不锈钢

可选颜色:
Optional color:



SS/G
拉丝银

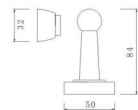

905A不锈钢 另有(加厚/A/B/C/E/G)型号

可选颜色:
Optional color:



SS/G
拉丝银

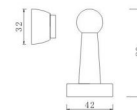

906 不锈钢 另有(A/B/C/E)型号

可选颜色:
Optional color:



SS/G
拉丝银

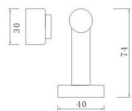

908 不锈钢 另有(A/B/C/E)型号

可选颜色:
Optional color:



SS/G
拉丝银

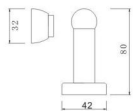

905A加厚新底 不锈钢

可选颜色:
Optional color:



SS/G
拉丝银

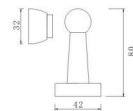

A8

可选颜色:
Optional color:



SS/G
拉丝银

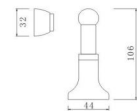

902 不锈钢

可选颜色:
Optional color:



SS/G
拉丝银

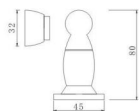

983不锈钢(亮)

可选颜色:
Optional color:



PC
镜面光

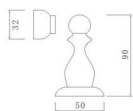

5186 拉丝银

可选颜色:
Optional color:



SS/G
拉丝银

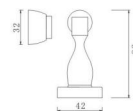

902 锌合金

可选颜色:
Optional color:



SS/G
拉丝银

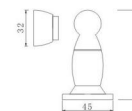

918 不锈钢

可选颜色:
Optional color:

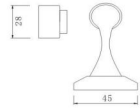

2006B 不锈钢

可选颜色:
Optional color:

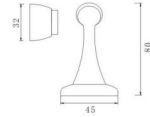

A1 不锈钢

可选颜色:
Optional color:

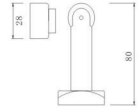

932实心(304不锈钢) 全不锈钢门吸品质终身保证

可选颜色:
Optional color:

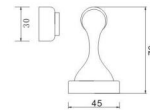

2001 (304精铸) 不锈钢

可选颜色:
Optional color:

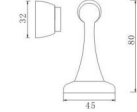

A2 不锈钢

可选颜色:
Optional color:

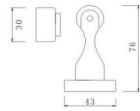

2006A 不锈钢

可选颜色:
Optional color:



932 不锈钢

可选颜色:
Optional color:

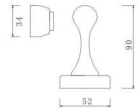

988 不锈钢

可选颜色:
Optional color:

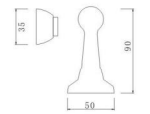

986 不锈钢

可选颜色:
Optional color:

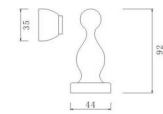

A6 不锈钢

可选颜色:
Optional color:

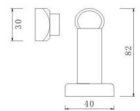

A8 不锈钢

可选颜色:
Optional color:

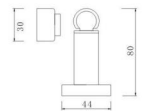

2006 K金

可选颜色:
Optional color:

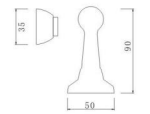

905 可调不锈钢

可选颜色:
Optional color:

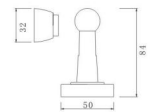

901 可调不锈钢

可选颜色:
Optional color:

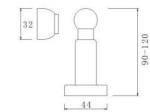

外贸可调

可选颜色:
Optional color:

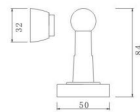

905红古铜

可选颜色:
Optional color:

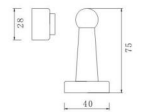

789-0可调

可选颜色:
Optional color:



932 拉丝银

可选颜色: ☆ ★
Optional color:
AB AC SS/G
青古铜 红古铜 镍拉丝

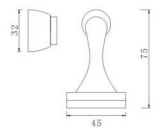

932 青古

可选颜色: ☆ ★
Optional color:
AB AC SS/G
青古铜 红古铜 镍拉丝

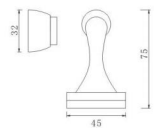

973不锈钢(气动) 本产品结构已申请专利

可选颜色:
Optional color:
SS/G
镍拉丝

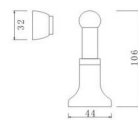

933 青古铜

可选颜色: ☆ ★
Optional color:
AB AC SS/G
青古铜 红古铜 镍拉丝

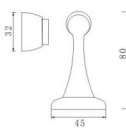

328 青古铜

可选颜色: ☆ ★
Optional color:
SS/G
镍拉丝

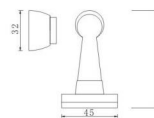

328 拉丝银(另有全实心加重)

可选颜色: ☆ ★
Optional color:
AB AC SS/G
青古铜 红古铜 镍拉丝

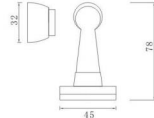

2001红古

可选颜色:
Optional color:
SS/G
镍拉丝

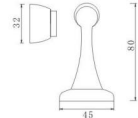

2001青古

可选颜色:
Optional color:
SS/G
镍拉丝



932AA青古

可选颜色:
Optional color:
SS
拉丝

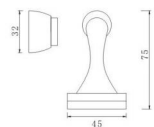

932AA红古

可选颜色:
Optional color:
SS
拉丝

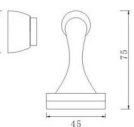

932全盖铁圈

可选颜色:
Optional color:
AB AC SS/G
青古铜 红古铜 镍拉丝

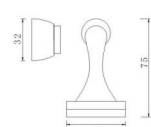

2006AA拉丝银

可选颜色:
Optional color:
AB AC SS/G
青古铜 红古铜 镍拉丝

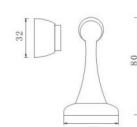

808 红古铜

可选颜色:
Optional color:
AB AC SS/G
青古铜 红古铜 拉丝银



808 拉丝银

可选颜色:
Optional color:
AB AC SS/G
青古铜 红古铜 拉丝银



808B 拉丝银

可选颜色:
Optional color:
AB AC SS/G
青古铜 红古铜 拉丝银



808B 红古

可选颜色:
Optional color:
AB AC SS/G
青古铜 红古铜 拉丝银

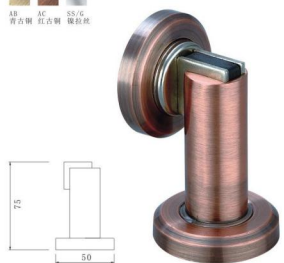

808B 青古

可选颜色:
Optional color:
AB AC SS/G
青古铜 红古铜 拉丝银



808B K金

可选颜色:
Optional color:
AB AC SS/G
青古铜 红古铜 拉丝银



808A 拉丝金

可选颜色:
Optional color:
AB AC SS/G
青古铜 红古铜 拉丝银



808A 青古铜

可选颜色:
Optional color:
AB AC SS/G
青古铜 红古铜 拉丝银



808A 拉丝银

可选颜色:
Optional color:
AB AC SS/G
青古铜 红古铜 拉丝银



最长尺寸10-350



908 不锈钢 加长

009 加长

808B 红古

可选颜色:
Optional color:
AB AC SS/G
青古铜 红古铜 拉丝银

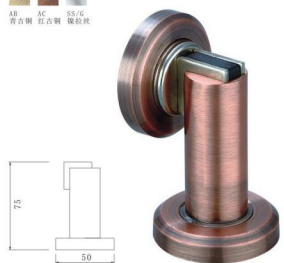

808B 青古

可选颜色:
Optional color:
AB AC SS/G
青古铜 红古铜 拉丝银



808B K金

可选颜色:
Optional color:
AB AC SS/G
青古铜 红古铜 拉丝银



808A 拉丝金

可选颜色:
Optional color:
AB AC SS/G
青古铜 红古铜 拉丝银



808A 青古铜

可选颜色:
Optional color:
AB AC SS/G
青古铜 红古铜 拉丝银



808A 拉丝银

可选颜色:
Optional color:
AB AC SS/G
青古铜 红古铜 拉丝银



部分品牌筒精盒系列

Part of the brand essence of Jane box series



部份吸塑产品品牌展示

Part of the blister products brand display



2001亚黑

可选颜色: ☆
Optional color:
沙黑

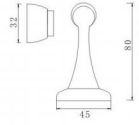

2001黑红

可选颜色: ☆
Optional color:
沙黑

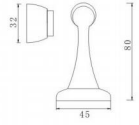

2001黑青

可选颜色: ☆
Optional color:
沙黑

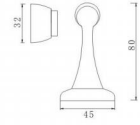

1688不锈钢拉丝
SUS 304 精铸不锈钢

可选颜色:
Optional color:
SS/G
拉丝

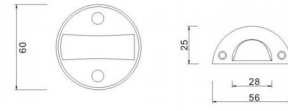

1688青古
SUS 304 精铸不锈钢

可选颜色:
Optional color:
SS/G
拉丝

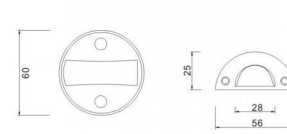

932黑红

可选颜色: ☆
Optional color:
沙黑

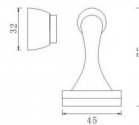

932亚黑

可选颜色: ☆
Optional color:
沙黑

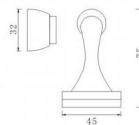

902青古铜

可选颜色: ☆
Optional color:
AB AC SS/G
青古铜 红古铜 拉丝

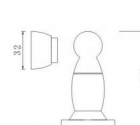

1688拉丝金
SUS 304 精铸不锈钢

可选颜色:
Optional color:
SS/G
拉丝

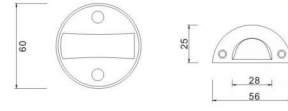

178 (实心) 青古铜

可选颜色: ☆
Optional color:
AB AC SS/G
青古铜 红古铜 拉丝

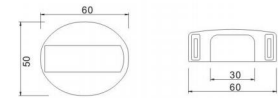

866A 拉丝银

可选颜色:
Optional color:
AC SS/G
红古铜 拉丝

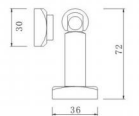

931拉丝银

可选颜色:
Optional color:
SS/G
拉丝

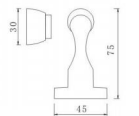

5186黄古铜

可选颜色:
Optional color:
AR SS/G
黄古铜 拉丝

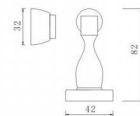

178亚黑

可选颜色:
Optional color:
SS/G
拉丝

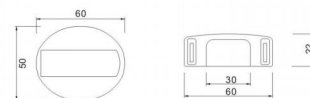

178 (实心) 拉丝银

可选颜色:
Optional color:
AB AC SS/G
青古铜 红古铜 拉丝

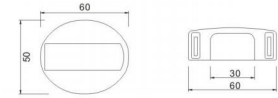

179 拉丝

可选颜色: ☆ ★

Optional color:
SS/G
拉丝银

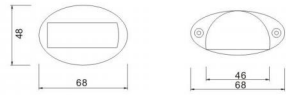

179 青古

可选颜色: ☆ ★

Optional color:
SS/G
拉丝银

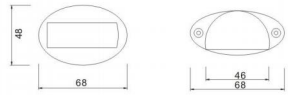

179 亮银

可选颜色:

Optional color:
SS/G
拉丝银



161 拉丝银

可选颜色:

Optional color:
SS/G
拉丝银

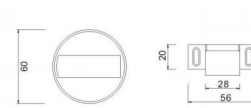

169 青古铜

可选颜色:

Optional color:
AB AC SS/G
青古铜 红古铜 拉丝银



169 拉丝银

可选颜色:

Optional color:
AB AC SS/G
青古铜 红古铜 拉丝银



179 拉丝金

可选颜色: ★

Optional color:
SS/G
拉丝银

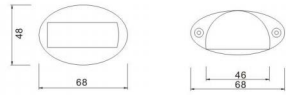

171 拉丝银

可选颜色:

Optional color:
SS/G
拉丝银

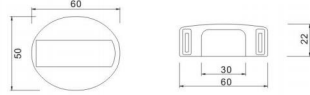

172 拉丝银

可选颜色:

Optional color:
SS/G
拉丝银



188 红古

可选颜色: ☆

Optional color:
SS/G
拉丝银

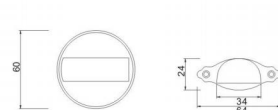

188 青古

可选颜色:

Optional color:
SS/G
拉丝银

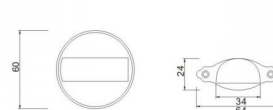

188 金加银

可选颜色:

Optional color:
SS/G
拉丝银

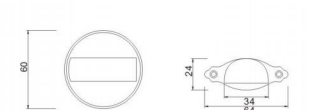

168 拉丝银

可选颜色:

Optional color:
SS/G
拉丝银

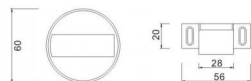

168 实心拉丝明装

可选颜色: ☆

Optional color:
SS/G
拉丝银

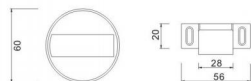

162 拉丝银

可选颜色:

Optional color:
SS/G
拉丝银



178 拉丝银 (空心)

可选颜色:

Optional color:
AB AC SS/G
青古铜 红古铜 拉丝银



005 门定

可选颜色:

Optional color:
SS/G GFB
拉丝银 金亮

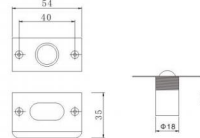

0051 门定

可选颜色:

Optional color:
SS/G
拉丝银

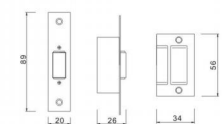

156不锈钢

可选颜色:
Optional color:

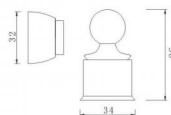

156拉丝银

可选颜色:
Optional color:

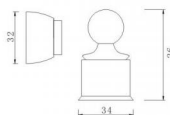

108地吸拉丝金

可选颜色:
Optional color:

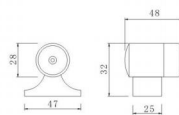

108地吸拉丝银

可选颜色:
Optional color:

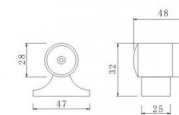

159拉丝银

可选颜色:
Optional color:

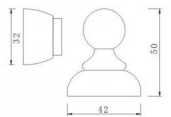

1066 (304不锈钢)

可选颜色:
Optional color:



108地吸(中底)拉丝银

可选颜色:
Optional color:

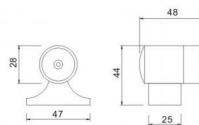

108青古

可选颜色: 古
Optional color:

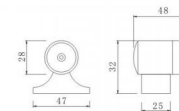
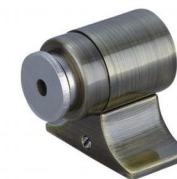

118地吸拉丝银

可选颜色:
Optional color:

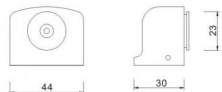

117拉丝银

可选颜色:
Optional color:

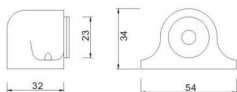

108地吸(加高)拉丝银

可选颜色:
Optional color:

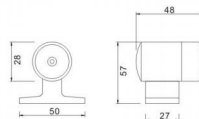

1088门顶(加高)拉丝银

可选颜色:
Optional color:



008暗装门顶

可选颜色:
Optional color:

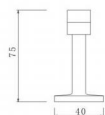

008A红古铜

可选颜色: ☆
Optional color:

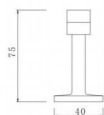
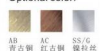

008A亮银

可选颜色:
Optional color:

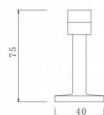

009 拉丝

可选颜色: ☆
Optional color:

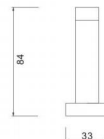

808 双向门顶

可选颜色:
Optional color:

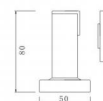

033防风门吸

可选颜色:
Optional color:

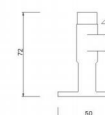

008A砂镍

可选颜色:
Optional color:

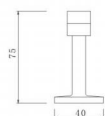

008A真金

可选颜色:
Optional color:

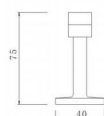

008A拉丝银

可选颜色: ☆ ★
Optional color:

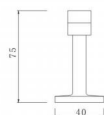
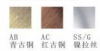

808-1 拉丝

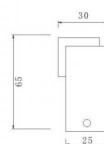

009-0 拉丝

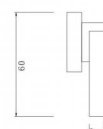

009-4 亮

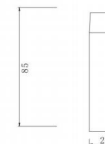

008 拉丝银(明装)

可选颜色:
Optional color:

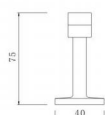

0081 青古门顶

可选颜色:
Optional color:

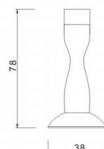

003 拉丝衣钩门顶

可选颜色:
Optional color:

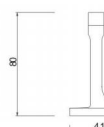

009-5 拉丝

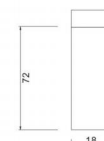

009-7 拉丝

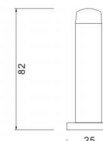

099 拉丝

可选颜色:
Optional color:

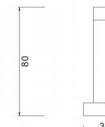

0023

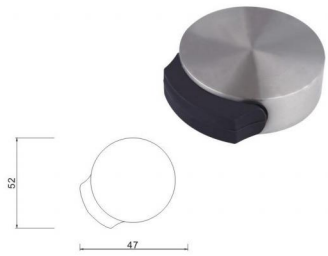

0029

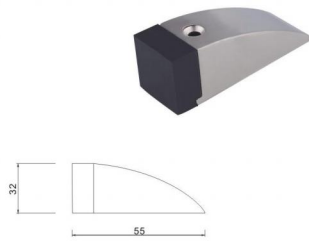

0024

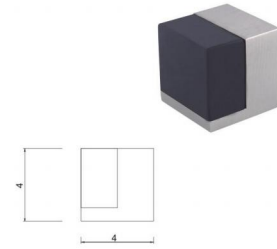

009-9

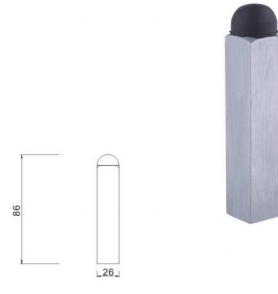

009-8



109



0020

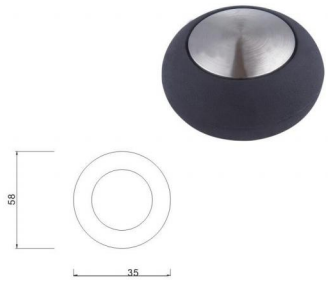

0081B

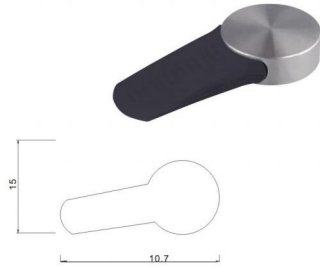

0082



0031

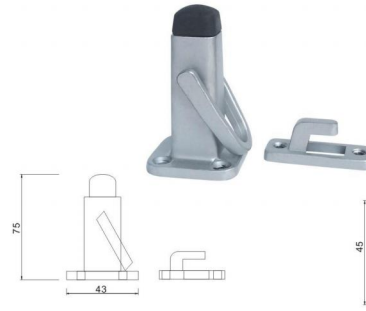

158 拉丝银

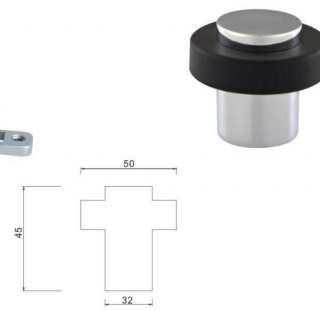

0025



0032



0033



0030

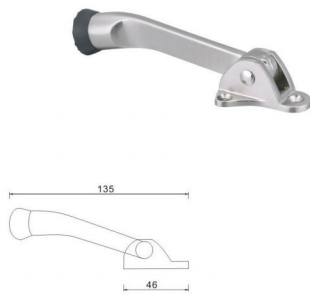

0021 门顶

可选颜色:
Optional color:

 仿古铜 红古铜 SS/G 拉丝银

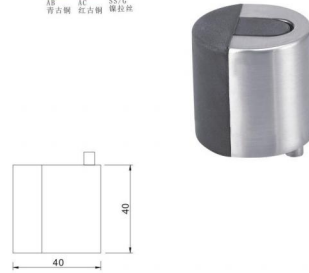

158 门顶铝

可选颜色:
Optional color:

 SS/G 拉丝银



158 拉丝银

可选颜色:
Optional color:

 SS/G 拉丝银



1888拉丝门顶

可选颜色:
Optional color:
拉丝 青古



1888青古门顶

可选颜色:
Optional color:
拉丝 青古



MD-8080-2



MD-6575-3



MD-6575-2



MD-9045-W



MD-9045-1



MD-8080-3



0022拉丝银



0022拉丝银

002 拉丝银

可选颜色: ☆ ★
Optional color:
拉丝 拉丝



防尘器



椭圆法兰
flange



25
大法兰
flange



25
六角法兰
flange

002A红古铜(带脚)

可选颜色: ☆ ★
Optional color:
AB AC AS SS/9
青古铜 青古铜 红古铜 拉丝银

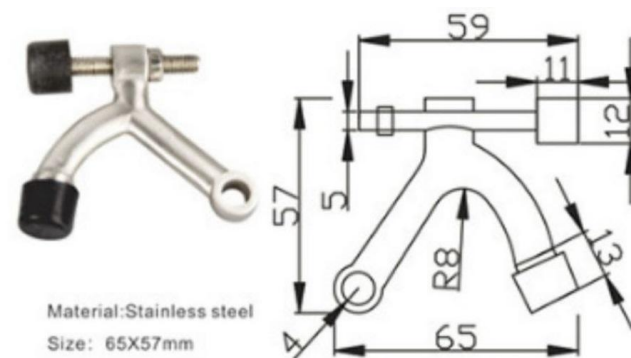

Material: Stainless steel
Size: 65X57mm

807 黑花

可选颜色:
Optional color:

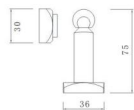

807 红

可选颜色:
Optional color:

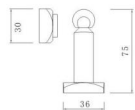

807 金

可选颜色:
Optional color:

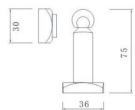

5185 精品红花

可选颜色:
Optional color:

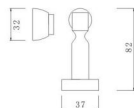

5185 精品黑花

可选颜色:
Optional color:

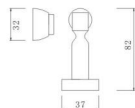

888 精品黑

可选颜色:
Optional color:

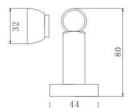

888 精品黑花

可选颜色:
Optional color:

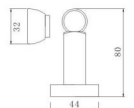

803 亮银

可选颜色:
Optional color:

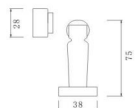

5185 亮银黑马

可选颜色:
Optional color:

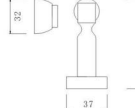

898 亮银

可选颜色:
Optional color:

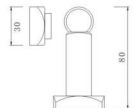

5185S 金粉

可选颜色:
Optional color:

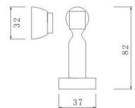

880S 亮银黑花

可选颜色:
Optional color:

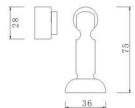

098 珍珠银

可选颜色:
Optional color:

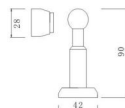

009 珍珠银(原003)

可选颜色:
Optional color:

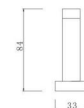

095 珍珠银

可选颜色:
Optional color:

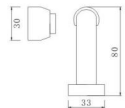

082 珍珠银加长

可选颜色:
Optional color:

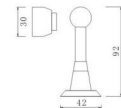

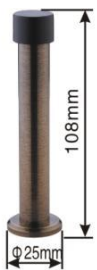

型号: HDS007(小圆柱-铝合金)
尺寸: $\Phi 25 \times 108 \text{mm}$



型号: HDS008(带钩-锌合金)
尺寸: $\Phi 40 \times 88 \text{mm}$



型号: HDS009(地吸-锌合金)
尺寸: $53 \times 30 \times 30 \text{mm}$



型号: HDS010(不锈钢)
尺寸: $\Phi 50 \times 95 \text{mm}$ (不锈钢底座)



型号: HDS011(灯塔-锌合金)
尺寸: $\Phi 38 \times 75 \text{mm}$

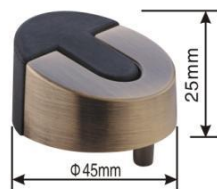

型号: HDS012(锌合金)
尺寸: $\Phi 45 \times 25 \text{mm}$



型号: HDS013(锌合金)
尺寸: $\Phi 40 \times 40 \text{mm}$

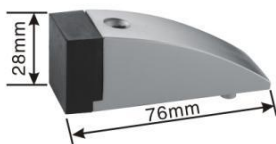

型号: HDS014(锌合金)
尺寸: $76 \times 28 \times 28 \text{mm}$

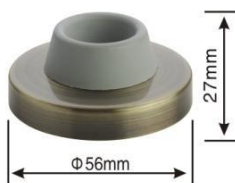

型号: HDS015(不锈钢)
尺寸: $\Phi 56 \times 27 \text{mm}$



型号: HDS016(不锈钢精铸)
尺寸: $\Phi 45 \times 75 \text{mm}$

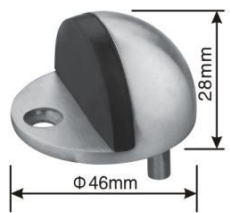

型号: HDS017(不锈钢精铸)
尺寸: $\Phi 46 \times 28 \text{mm}$

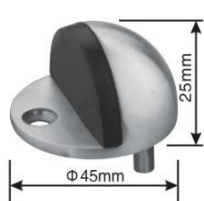

型号: HDS017B(不锈钢精铸)
尺寸: $\Phi 45 \times 25 \text{mm}$



型号: HDS018(不锈钢)
尺寸: $\Phi 29 \times 51 \text{mm}$



型号: HDS018B(锌合金)
尺寸: $\Phi 29 \times 51 \text{mm}$



型号: HDS019(不锈钢)
尺寸: $\Phi 29 \times 40 \text{mm}$



型号: HDS019B(锌合金)
尺寸: $\Phi 29 \times 40 \text{mm}$

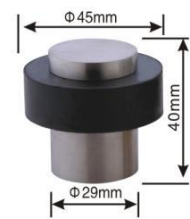

型号: HDS020(不锈钢)
尺寸: $\Phi 29 \times 40 \text{mm}$

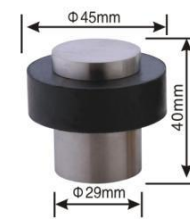

型号: HDS020B(锌合金)
尺寸: $\Phi 29 \times 40 \text{mm}$



型号: HDS021(不锈钢)
尺寸: $\Phi 46 \times 98 \text{mm}$



型号: HDS022(不锈钢)
尺寸: $\Phi 46 \times 98 \text{mm}$



型号: HDS023(不锈钢)
尺寸: $\Phi 50 \times 95 \text{mm}$



型号: HDS024(不锈钢)
尺寸: $\Phi 50 \times 90 \text{mm}$



型号: HDS025(锌合金)
尺寸: $45 \times 31 \times 38 \text{mm}$

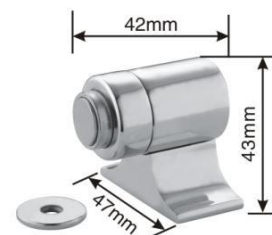

型号: HDS026(锌合金)
尺寸: $47 \times 42 \times 43 \text{mm}$



型号: HDS027(锌合金)
尺寸: $\Phi 50 \times 75 \text{mm}$

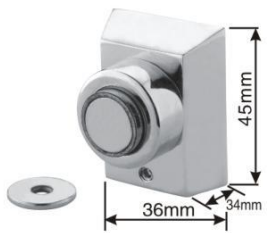

型号: HDS028(锌合金)
尺寸: 36X34X45mm

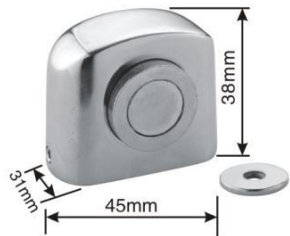

型号: HDS029(不锈钢精铸)
尺寸: 45X31X38mm



型号: HDS030(锌合金)
尺寸: Φ 40X75mm

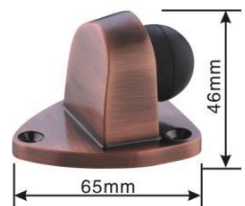

型号: HDS031(锌合金)
尺寸: 65X52X46mm

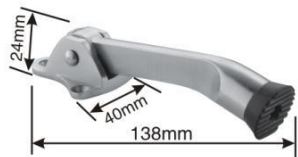

型号: HDS032(锌合金)
尺寸: 138X40X24mm

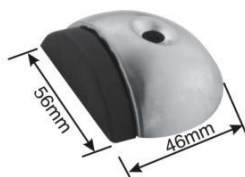

型号: HDS033(不锈钢)
尺寸: 56X46X18mm



型号: HDS034(锌合金半球门顶)
尺寸: Φ 44X24mm

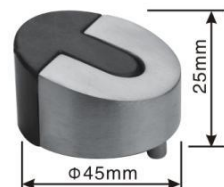

型号: HDS035(不锈钢精铸)
尺寸: Φ 45X25mm

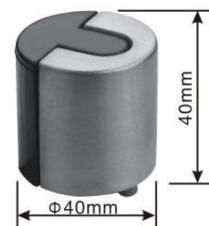

型号: HDS036(不锈钢精铸)
尺寸: Φ 40X40mm

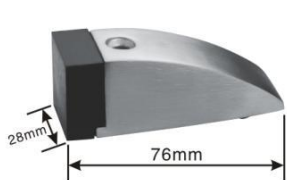

型号: HDS037(不锈钢精铸)
尺寸: 76X28X28mm

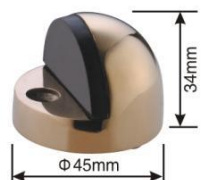

型号: HDS038(不锈钢精铸)
尺寸: Φ 45X34mm



型号: HDS039(不锈钢精铸)
尺寸: 53X32X30mm



型号: HDS040(不锈钢精铸)
尺寸: Φ 38X74mm



型号: HDS041(不锈钢精铸)
尺寸: Φ 50X75mm



型号: HDS042(不锈钢精铸)
尺寸: Φ 42X77mm

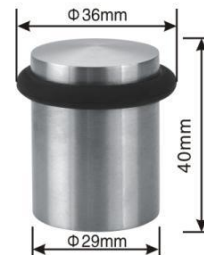

型号: HDS043(不锈钢)
尺寸: Φ 29X40mm

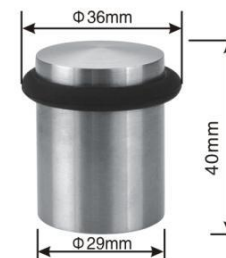

型号: HDS043B(锌合金)
尺寸: Φ 29X40mm



型号: HDS044(不锈钢)
尺寸: Φ 31X70mm

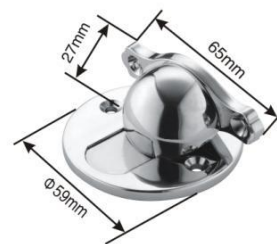

型号: HDS045(锌合金)
尺寸: Φ 59X65mm



型号: HDS046(锌合金)
尺寸: Φ 46X75mm



型号: HDS047(锌合金)
尺寸: Φ 29X45mm

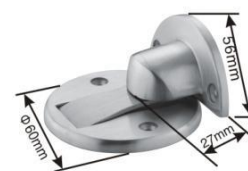

型号: HDS048(不锈钢精铸)
尺寸: Φ 60X56mm



型号: HDS048B(不锈钢精铸暗孔)
尺寸: Φ 60X56X27mm



型号: HDS049(不锈钢精铸)
尺寸: Φ 29X42mm



型号: HDS050(锌合金)
尺寸: $\Phi 29 \times 42 \text{mm}$

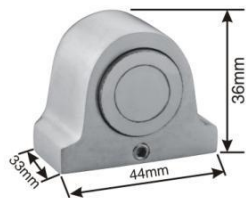

型号: HDS051(不锈钢精铸)
尺寸: $44 \times 33 \times 36 \text{mm}$



型号: HDS052(不锈钢)
尺寸: $\Phi 25 \times 40 \text{mm}$



型号: HDS062
(不锈钢)
尺寸: $\Phi 54 \times 87 \text{mm}$



型号: HDS063
(铝门顶)
尺寸: $\Phi 19 \times 75 \text{mm}$



型号: HDS064
(铝门顶)
尺寸: $\Phi 34 \times 75 \text{mm}$



型号: HDS053(不锈钢精铸)
尺寸: $\Phi 29 \times 45 \text{mm}$



型号: HDS054(不锈钢精铸)
尺寸: $\Phi 50 \text{mm}$
(高度调节范围70-95mm)



型号: HDS055(不锈钢)
尺寸: $\Phi 50 \times 55 \text{mm}$



型号: HDS065
(铝芯不锈钢门顶)
尺寸: $\Phi 25 \times 45 \text{mm}$



型号: HDS066
(锌合金)
尺寸: $\Phi 60 \times 56 \text{mm}$



型号: HDS067(不锈钢冲压)
尺寸: $\Phi 48 \times 85 \text{mm}$

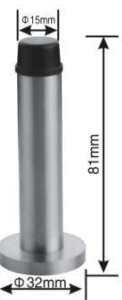

型号: HDS056(不锈钢)
尺寸: $\Phi 32 \times 81 \text{mm}$

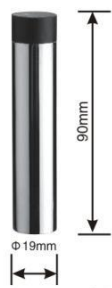

型号: HDS057(不锈钢)
尺寸: $\Phi 19 \times 90 \text{mm}$

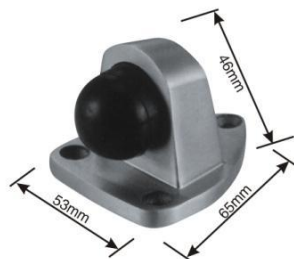

型号: HDS058(不锈钢精铸)
尺寸: $65 \times 53 \times 46 \text{mm}$



型号: HDS068(不锈钢冲压)
尺寸: $\Phi 42 \times 73 \text{mm}$



型号: HDS069(不锈钢冲压)
尺寸: $\Phi 34 \times 92 \text{mm}$



型号: HDS070衣钩门顶(不锈钢)
尺寸: $\Phi 50 \times 95 \text{mm}$



型号: HDS071带磁吸门顶
(不锈钢)
尺寸: $\Phi 47 \times 35 \text{mm}$



型号: HDS059(不锈钢精铸)
尺寸: $\Phi 40 \times 75 \text{mm}$



型号: HDS060(不锈钢)
尺寸: $\Phi 48 \times 82 \text{mm}$



型号: HDS061(不锈钢)
尺寸: $\Phi 54 \times 90 \text{mm}$

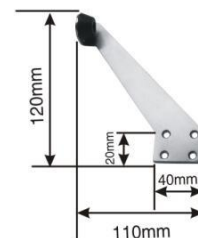

型号: HDS072左门顶(不锈钢冲压)
尺寸: $40 \times 110 \times 120 \text{mm}$

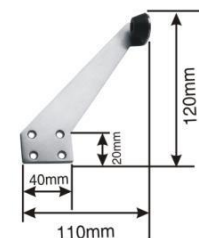

型号: HDS073右门顶(不锈钢冲压)
尺寸: $40 \times 110 \times 120 \text{mm}$



型号: HDS074(不锈钢)
尺寸: $\Phi 29 \times 42 \text{mm}$

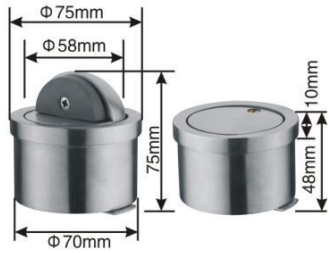

型号: HDS075 隐形门顶(不锈钢精铸)
尺寸: $\Phi 75 \times 75 \text{mm}$

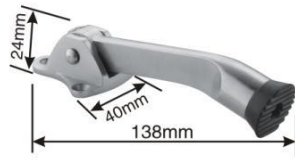

型号: HDS076(不锈钢精铸)
尺寸: $138 \times 40 \times 24 \text{mm}$

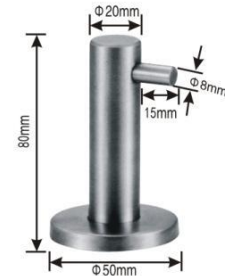

型号: HDS077(不锈钢)
尺寸: $50 \times 80 \text{mm}$



型号: HDS087(不锈钢)
尺寸: $28 \times 47 \text{mm}$

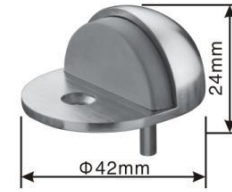

型号: HDS088(不锈钢精铸)
尺寸: $50 \times 41 \times 24 \text{mm}$



型号: HDS089(不锈钢)
尺寸: $\Phi 50 \times 95 \text{mm}$

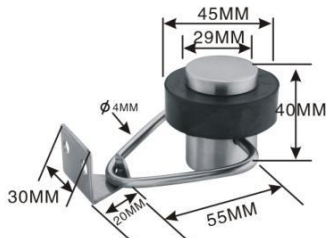

型号: HDS078(不锈钢)
尺寸: $\Phi 29 \times 40 \times 45 \text{mm}$



型号: HDS079(不锈钢)
尺寸: $\Phi 25 \times 100 \text{mm}$

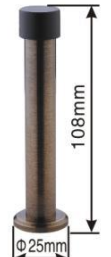

型号: HDS080(不锈钢)
尺寸: $\Phi 25 \times 108 \text{mm}$

(五) 不锈钢(铁)门挡



型号: C800
尺寸: $125 \times 50 \times 32 \text{mm}$



型号: S801
尺寸: $\Phi 100 \times 42 \text{mm}$



型号: D801
尺寸: $\Phi 100 \times 42 \text{mm}$



型号: S801G
尺寸: $\Phi 97 \times 45 \text{mm}$

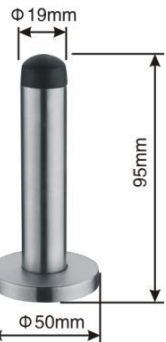

型号: HDS081(不锈钢)
尺寸: $\Phi 50 \times 95 \text{mm}$

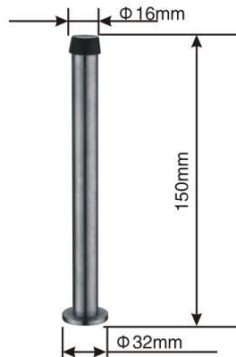

型号: HDS082(不锈钢实心棒加工)
尺寸: $\Phi 32 \times 150 \text{mm}$

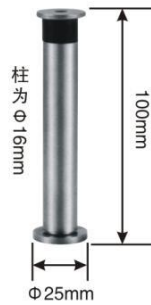

型号: HDS083(不锈钢门吸)
尺寸: $25 \times 100 \text{mm}$



型号: HDS084(不锈钢精铸)
尺寸: $68 \times 48 \times 27 \text{mm}$ $68 \times 27 \text{mm}$



型号: HDS085(不锈钢精铸门吸)
尺寸: $32 \times 88 \text{mm}$



型号: HDS086(不锈钢精铸)
尺寸: $38 \times 90 \text{mm}$



型号: D802
尺寸: $\Phi 68 \times 70 \text{mm}$



型号: S802
尺寸: $\Phi 68 \times 70 \text{mm}$



型号: S802P
尺寸: $\Phi 75 \times 86 \text{mm}$



型号: S803G1
尺寸: $\Phi 68 \times 72 \text{mm}$



型号: D803
尺寸: $\Phi 68 \times 72 \text{mm}$



型号: S803B
尺寸: $\Phi 80 \times 80 \text{mm}$